

Attuatore a stelo per:
finestre a sporgere, cupole,
finestre a lamelle,
pale frangisole.

Rod actuator for:
top hinged windows, domes,
sunshades, louvre windows.

450N

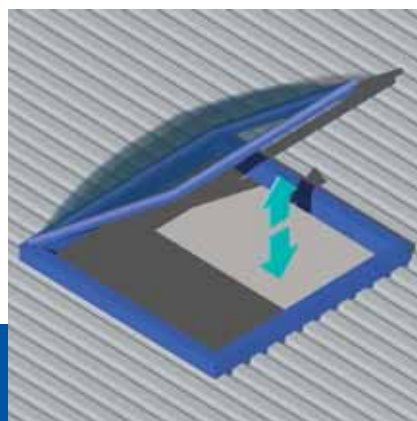
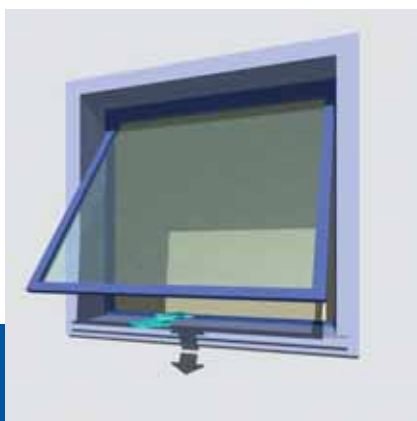

Corsa regolabile
Adjustable stroke

Versioni disponibili:
230V AC e 24V CC
Available versions:
230V AC and 24V DC

Staffa di fissaggio scorrevole lungo tutto il corpo dell'attuatore
Fixing bracket sliding along the whole body

Elevato grado di protezione
High protection degree

Assenza di manutenzione
Maintenance free

Grado di protezione: IP 55 / Protection degree: IP 55

Fine corsa chiusura-apertura: Microinterruttore / Limit switch closing-opening: Microswitch

Colore: Anodizzato Argento (A) o Anodizzato Nero (N) / Colour: Anodised Silver (A) or Anodised Black (N)

DESCRIZIONE DI CAPITOLATO

Attuatore elettrico lineare MINGARDI con movimento a stelo rigido ad alta resistenza ai carichi di punta. Funzionamento con tensione di alimentazione 230V~ 50 Hz o 24V CC Conforme alle Direttive 73/23 LVD – 89/336 EMC come modificate da 93/68 CE (per il funzionamento a 24V CC conforme alle Direttive 89/336 EMC come modificate da 93/68 CE). Predisposto di sistema di fine corsa con microinterruttori e protezione tramite limitatore di corrente. Corsa regolabile dall'esterno a mezzo registro, collegabile in parallelo. Colori disponibili: anodizzato argento o nero. Completo di accessori di fissaggio.

DESCRIPTION OF SPECIFICATIONS

MINGARDI linear electric actuator with movement by a stiff rod that is highly resistant to maximum loads. Operating voltage: 230V~ 50 Hz o 24V DC. In conformity with Directives 73/23 LVD - 89/336 EMC as modified by 93/68 CE (compliant with Directives 89/336 EMC as modified by 93/68 CE for 24V DC operation). Prepared in advance for limit switch system and protection by a current limiter. The stroke can be adjusted from the outside by a register and it can be connected in parallel. Colours available: anodised silver or black. Complete with fixing supports.

DATI TECNICI Euro 1 230V AC / TECHNICAL FEATURES Euro 1 230V AC

CODICE CODE	DESCRIZIONE DESCRIPTION	VOLTAGGIO VOLTAGE	SPINTA TRAZIONE THRUST TENSILE	CORSA STROKE	ASSORBIMENTO MAX CONSUMPTION MAX	VELOCITÀ MIN. SPEED MIN.
2700036	EURO 1 200 mm - A	230 V~ / 50 Hz	450 N	200 mm	30 W	ca. 8 mm/s
2700037	EURO 1 200 mm - N	230 V~ / 50 Hz	450 N	200 mm	30 W	ca. 8 mm/s
2700040	EURO 1 300 mm - A	230 V~ / 50 Hz	450 N	300 mm	30 W	ca. 8 mm/s
2700041	EURO 1 300 mm - N	230 V~ / 50 Hz	450 N	300 mm	30 W	ca. 8 mm/s
2700044	EURO 1 500 mm - A	230 V~ / 50 Hz	450 N	500 mm	30 W	ca. 8 mm/s
2700045	EURO 1 500 mm - N	230 V~ / 50 Hz	450 N	500 mm	30 W	ca. 8 mm/s
2700032	EURO 1 70 mm - A	230 V~ / 50 Hz	1000 N	70 mm	23 W	ca. 3 mm/s
2700033	EURO 1 70 mm - N	230 V~ / 50 Hz	1000 N	70 mm	23 W	ca. 3 mm/s
2700386	EURO 1 300 mm - A	230 V~ / 50 Hz	1000 N	300 mm	23 W	ca. 3 mm/s
2700387	EURO 1 300 mm - N	230 V~ / 50 Hz	1000 N	300 mm	23 W	ca. 3 mm/s

I VALORI PRESTAZIONALI RIPORTATI NELLA TABELLA SONO VERIFICATI AD UNA TEMPERATURA DI FUNZIONAMENTO DA -10°C/+40°C CON UN'UMIDITÀ RELATIVA MASSIMA DEL 60%.
THE VALUES INDICATED ON THE TABLE WERE RECORDED IN A CLIMATIC TEST CHAMBER AT OPERATING TEMPERATURES BETWEEN -10°C/+40°C WITH MAX 60% RELATIVE HUMIDITY.

DATI TECNICI Euro 1 24V CC / TECHNICAL FEATURES Euro 1 24V DC

CODICE CODE	DESCRIZIONE DESCRIPTION	VOLTAGGIO VOLTAGE	SPINTA TRAZIONE THRUST TENSILE	CORSA STROKE	ASSORBIMENTO MAX CONSUMPTION MAX	VELOCITÀ MIN. SPEED MIN.
2700038	EURO 1 200 mm - A	24 V =	450 N	200 mm	22 W	ca. 8 mm/s
2700039	EURO 1 200 mm - N	24 V =	450 N	200 mm	22 W	ca. 8 mm/s
2700042	EURO 1 300 mm - A	24 V =	450 N	300 mm	22 W	ca. 8 mm/s
2700043	EURO 1 300 mm - N	24 V =	450 N	300 mm	22 W	ca. 8 mm/s
2700046	EURO 1 500 mm - A	24 V =	450 N	500 mm	22 W	ca. 8 mm/s
2700047	EURO 1 500 mm - N	24 V =	450 N	500 mm	22 W	ca. 8 mm/s
2700034	EURO 1 70 mm - A	24 V =	1000 N	70 mm	18 W	ca. 3 mm/s
2700035	EURO 1 70 mm - N	24 V =	1000 N	70 mm	18 W	ca. 3 mm/s
2700388	EURO 1 300 mm - A	24 V =	1000 N	300 mm	18 W	ca. 3 mm/s
2700392	EURO 1 300 mm - N	24 V =	1000 N	300 mm	18 W	ca. 3 mm/s

Euro 1 Disegno dimensionale / Euro 1 Scale drawing

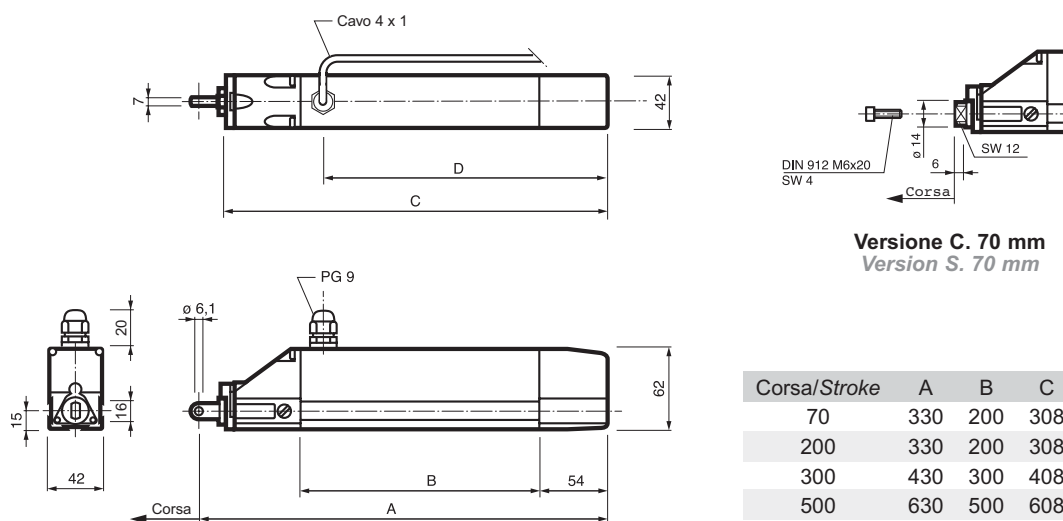

ACCESSORI DI COMANDO: per informazioni si prega di contattare il nostro servizio tecnico-commerciale o consultare il sito www.mingardimotor.com
CONTROL ACCESSORIES: please contact our technical support service for further information or consulting our web-site www.mingardimotor.com

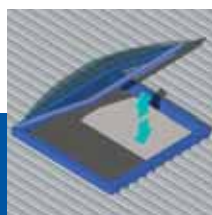

Accessori - Ricambi / Accessories - Spare parts

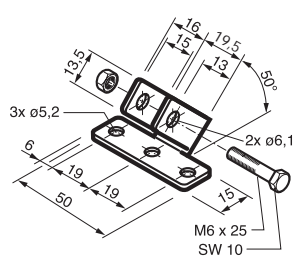

2700064

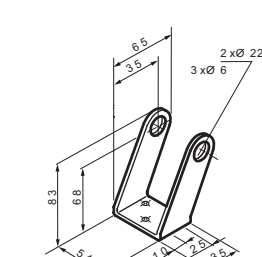

2700393

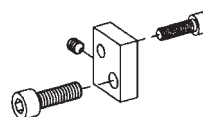

2700693

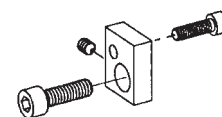

2700694

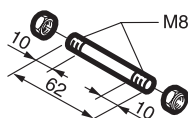

2700102

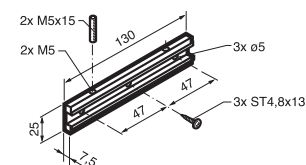

2700105

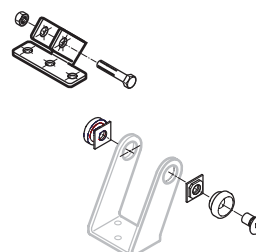

2700107

ACCESSORI DI FISSAGGIO / FIXING ACCESSORIES

CODICE CODE	DESCRIZIONE DESCRIPTION
2700102	Perno anteriore per versioni frangisole Front pin for sunshades application

RICAMBI / SPARE PARTS

CODICE CODE	DESCRIZIONE DESCRIPTION
2700064	Gruppo staffa anteriore per infisso Front bracket for window frames
2700393	Staffa supporto motore Motor support bracket
2700107	2700064 + accessori per staffa 2700393 (esclusa) 2700064 + accessories for bracket 2700393 (not included)

ACCESSORI DI FISSAGGIO / FIXING ACCESSORIES C/S 70 mm

CODICE CODE	DESCRIZIONE DESCRIPTION
2700693	Gruppo accessori per forbici GEZE OL 90 Fittings for snap lock GEZE OL 90
2700694	Gruppo accessori per forbici GEZE OL 100 Fittings for snap lock GEZE OL 100

RICAMBI Corsa 70 mm / SPARE PARTS Stroke 70 mm

CODICE CODE	DESCRIZIONE DESCRIPTION
2700105	Gruppo staffa supporto motore Motor support bracket