

DEA[®]



SLIDING



GULLIVER

Automation for industrial sliding gates



Electromechanical operator for industrial sliding gates

GULLIVER

FOR THE GREAT PERFORMANCES



GULLIVER is the automation for sliding gates

from 1000 kg to 2200 kg, where an intensive duty is required.

The **sturdiness** and the choice of the details are guarantee of **reliability** in time. Thanks to the electronic clutch, the **safety** is assured.

The control board is integrated in the case, making so still easier the already quick installation of Gulliver.



RANGE

GULLIVER

230V a.c.

15RR: 230V a.c. single phase operator, with built in 203RR* control panel.

24V d.c. for gates up to 1000 Kg

10/24RRS/F: 24V dc operator for gates up to 1000 Kg. with built in 124RRS* control board and limit switches

10/24RRSB/F: 24 V d.c. operator for gates up to 1000 Kg with built in 124RRS* control board, limit switches and 2 integrated batteries 12 V - 4 Ah.

400V a.c. for gates up to 2200 Kg

22RRT: 400V ac three phases operator for gates up to 2200 Kg. with built in 400RR* control board.

22RRTM6: 400V ac three phases operator for gates up to 2200 Kg. with built in 400RR* control board and M6 pinion.

22RRTF: 400V ac three phases operator for gates up to 2200 Kg. with built in 400RR* control board and electromechanical brake.

400V ac without control board, for gates up to 2200 Kg

2000: for gates up to 2200 Kg., without control board with electromechanical break.

2000SF: for gates up to 2200 Kg., without control board, without break but with mechanical force adjustment.

** all control boards included in the RR range come equipped with a 2-channel wireless 433 Mhz receiver, pedestrian opening, electronic adjustment of speed and force, reverser function on obstacle and slow-down. 400RR control board has an anti-inertia braking device.*

DEA System control boards are planned to optimize the performances of Gulliver range.

The models

- Electromechanical automation, 230V ac or 400V ac and 24V dc.
- Suitable for gates from 1000 kg to 2200 kg.
- Suitable for intensive, industrial and collective operation.
- Easy to install, thanks to the adjustable fixing plate.
- Integrated limit-switch.
- Simple unlocking system by key.
- Electromechanical brake to get a more immediate stop of the gate.
- Internal ventilation to get a more intensive duty.
- Grease soaked gear motor.
- Silent.

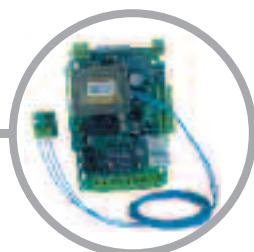

203RR
control board.

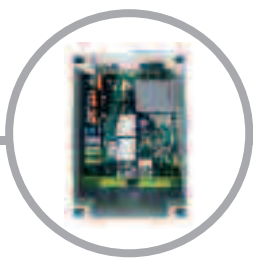

400RR
control board.



124RRS
control board.



Integrated
limit-switch
in opening
and closing.

accessories

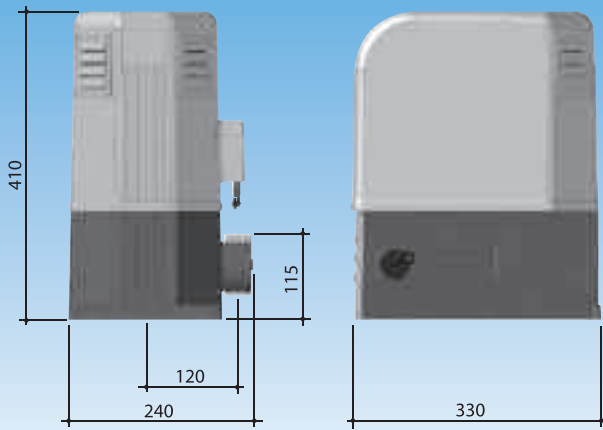

Art. 112
22 x 22 GALVANIZED rack.



Art. 113
30 x 12 GALVANIZED rack
with zinc-plated spacers.



Art. 116
M6 rack.

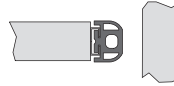

Art. Soft
Safety rubber profile (complete with
aluminium base) useful to reduce the
impact forces. To be used together
with control boards of range RR.12mt



Simple unlocking system by key.

Model	15RR	22RRT - 22RRTM6 2000 - 2000SF 22RRTF	10/24/RRS/F 10/24/RRSB/F
Motor power supply (V)	230 a.c.	400 a.c.	24 a.c.
Capacity (W)	450	1200	200
Incorporated condenser (µF)	30	-	-
Duty cycle (%)	60%	80%	70%
Max trust (N)	700	1650	350
Weight with packing (Kg)	30	30	30
Operating temperature (°C)	- 20 ÷ + 60	- 20 ÷ + 60	- 20 ÷ + 60
Motor thermal protection (°C)	140°	-	-
Speed (m/min)	10	10	10,5
Protection degree	IPX4	IPX4	IPX4



Sectional and garage doors

LIVI 902

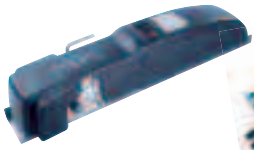

SPAZIO



LIVI 800 C



LATO



LIVI 550PL

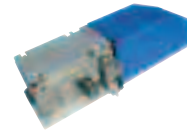

Swing gates

LIVI 500

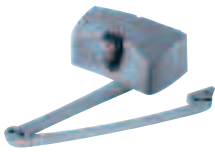

ANGOLO



GHOST 200



OLI 600



WING 302



LOOK

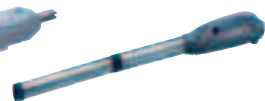

Sliding gates

LIVI



GULLIVER



Electromechanical barriers

PASS



STOP



Roller shutter

WILL

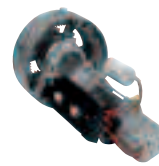

the products

the accessories



Digikey:
Safe and reliable,
available wireless
and hard-wired.



Safety beams:
reliable and easy
to install.



Control boards:
230V a.c. e 24V d.c.,
exact and simple
programming.



Flashing light
with built-in
433,92 Mhz
aerial.

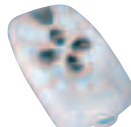

Radio Devices:
Frequency 433,92 Mhz
Rolling Code
or cloneable



Programming keyboard for
transponder and wireless
transmission systems; it allows
you to personalize installations
with fitter/installation codes.



DEA SYSTEM S.p.A.

Automation for gates, doors and barriers

Via della Tecnica, 6 - 36013 PIOVENE ROCCHETTE (VI)

Telefono: + 39 0445 550789 - Telefax: + 39 0445 550265

www.deasystem.com - deasystem@deasystem.com

DEALER STAMP



ISO 9001 certified company
Certificate n. 50 100 5350