



DEA[®]



SLIDING



LIVI

Automation for sliding gates



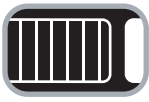

Electromechanical operator for sliding gates

LIVI

THE STURDINESS, BORN OF THE LONG EXPERIENCE

LIVI is the operator for sliding gates up to 900 kg, which combines a great **sturdiness** and **reliability** with an agreeable and original design, which has been marking out this product for several years.

Thanks to the mechanical or electronic clutch, the **safety** is assured.

The control board is integrated in the case, making so still easier the already quick installation of Livi 400 and its programming is rapid, precise and stable.



RANGE LIVI

Range RR*

6RR: operator 230V ac, for gates up to 600 kg, built-in control board art. 203RR*.

9RR: operator 230V ac, for gates up to 900 kg, built-in control board art. 203RR*.

805RR: operator 230V ac, for gates up to 800 kg, built-in control board art. 203RR*, not self-locking.

5/24RR/F: operator 24V dc, for gates up to 500 kg, built-in control board art. 124RR*, built in limit switches.

5/24RRB/F: operator 24V dc, for gates up to 500 kg, built-in control board art. 124RR*, 2 integrated batteries 12V 1,2Ah, built in limit switches.

8/24RR/F: operator 24V dc, for gates up to 800 kg, built-in control board art. 124RR*, built in limit switches.

8/24RRB/F: operator 24V dc, for gates up to 800 kg, built-in control board art. 124RR*, 2 integrated batteries 12V 1,2Ah, built in limit switches.

**all control boards included in the RR range come equipped with a 2-channel wireless receiver 433 Mhz, pedestrian opening, electronic adjustment of speed and force, reverser function on obstacle and slow-down.*

All functions are adjusted by 3 buttons and a digital display.

Other 230V models:

400: operator 230V ac, for gates up to 400 kg, with mechanical clutch.

403E: operator 230V ac, for gates up to 400 Kg., built-in control board art. 212E

800: operator 230V ac, for gates up to 800 kg, with mechanical clutch.

803E: operator 230V ac, for gates up to 800 Kg., built-in control board art. 212E

804: operator 230V ac, for gates up to 800 kg, with mechanical clutch, not self-locking.

DEA System control boards are planned to optimize the performances of Livi range.

It is suggested to use articles with control boards integrated.

The models

- Product in conformity with European standards.
- Electromechanical automation, 230V ac and 24V dc
- Suitable for gates up to 900 kg.
- Easy to install, thanks to the adjustable fixing plate.
- Integrated limit switches (on 230V ac versions).
- Simple unlocking system by key.
- Mechanical and electronic clutch (on RR models).
- Grease soaked gear motor.
- Silent.



Simple unlocking system by key.



Metal body and highly sturdy components.

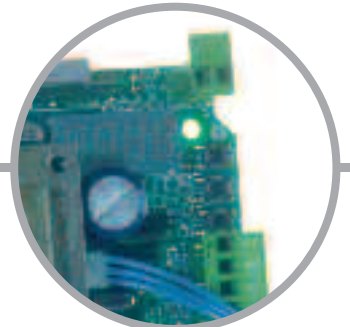

All control boards included in the RR range can be easily programmed through display and 3 buttons.

accessories

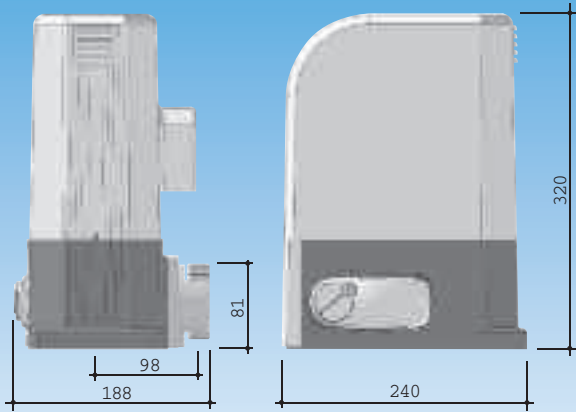

Art. III
NYLON rack.



Art. I12
22x22 GALVANIZED
rack.



Art. I13
30x12 GALVANIZED rack
with zinc-plated spacers.



Art. 460
Foundation plate to be
placed in the concrete.



Art. 450
Unlocking device
with cable.



Art. BLIND
Safety enclosure to place COD
external unlocking device handle.

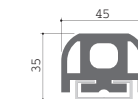

Art. SOFT
Safety rubber profile (complete with
aluminium base) useful to reduce the
impact forces. To be used together
with control boards of range RR

Technical information

Model	400 6RR - 403E	800 9RR - 803E	804 805RR	5/24RR/F 5/24RRB/F	8/24RR/F 8/24RR/BF
Motor power supply (V)	230 V a.c.	230 V a.c.	230 V a.c.	24 V d.c.	24 V d.c.
Capacity (W)	320	450	350	80	80
Duty cycle	30%	30%	30%	80%	80%
Max thrust (N)	340	490	275	210	260
Operating temperature (°C)	-20°÷40°	-20°÷40°	-20°÷40°	-20°÷40°	-20°÷40°
Speed (m/min)	10	10	10,8	10	8,2
Protection level	IPX4	IPX4	IPX4	IPX4	IPX4
Weight with packing (Kg)	11	12,5	12,5	12	12

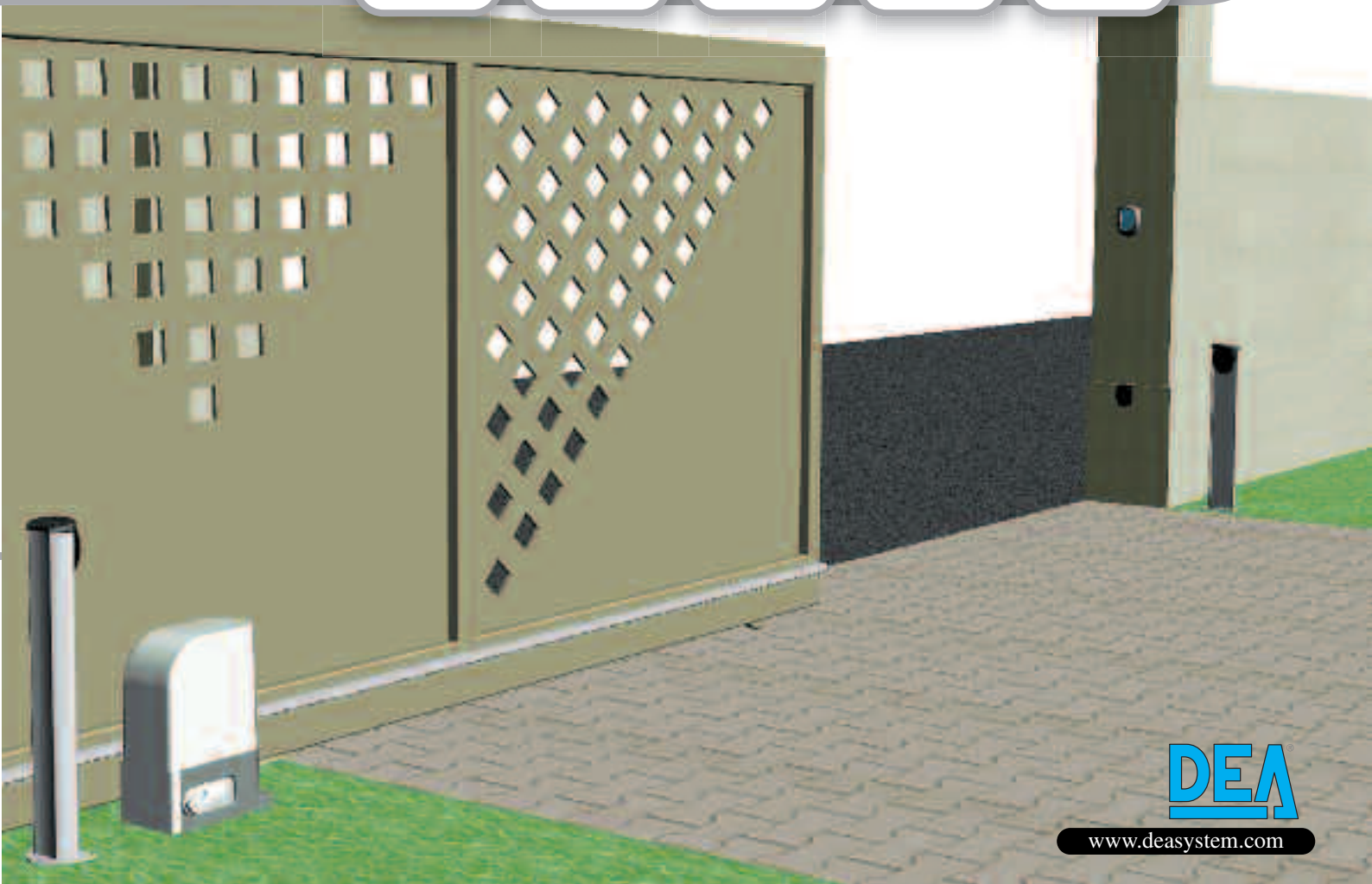

Sectional and garage doors

LIVI 902



SPAZIO



LIVI 800 C



LATO



LIVI 550PL

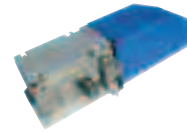

Swing gates

LIVI 500

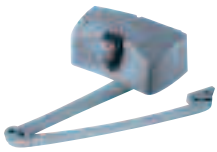

ANGOLO



GHOST 200

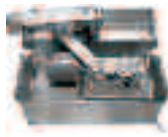

OLI 600



WING 302



LOOK

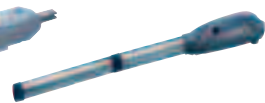

Sliding gates

LIVI



GULLIVER



Electromechanical barriers

PASS



STOP



Roller shutter

WILL

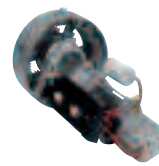

the products

the accessories



Digikey:
Safe and reliable,
available wireless
and hard-wired.



Safety beams:
reliable and easy
to install.



Control boards:
230V a.c. e 24V d.c.,
exact and simple
programming.



Flashing light
with built-in
433,92 Mhz
aerial.

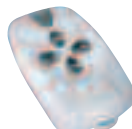

Radio Devices:
Frequency 433,92 Mhz
Rolling Code
or cloneable



Programming keyboard for
transponder and wireless
transmission systems; it allows
you to personalize installations
with fitter/installation codes.



DEA SYSTEM S.p.A.

Automation for gates, doors and barriers

Via della Tecnica, 6 - 36013 PIOVENE ROCCHETTE (VI)

Telefono: + 39 0445 550789 - Telefax: + 39 0445 550265

www.deasystem.com - deasystem@deasystem.com

DEALER STAMP



ISO 9001 certified company
Certificate n. 50 100 5350